

*Operating Instructions.....Page 12*

# **TCS 180**

---

## ***Pumping Station Control Unit***



# Contents

---

	Seite		Seite
<b>1. Important For Your Safety .....</b>	<b>3</b>	<b>5. Operations .....</b>	<b>7</b>
<b>2. Understanding The TCS 180.....</b>	<b>4</b>	5.1. Operations Without The High Vacuum Valve.....	7
2.1. For Your Orientation .....	4	5.2. Operations With The High Vacuum Valve .....	7
2.2. Product Description .....	4	5.3. Pumping Station Behaviour In Case Of Malfunction... Cofiguration 1, 2 And 3.....	8 8
Proper Use .....	4	<b>6. What To Do In Case Of Breakdowns ? .</b>	<b>9</b>
Improper Use .....	4	<b>7. Maintenance, Service .....</b>	<b>9</b>
2.3. TCS Front View .....	5	<b>8. Technical Data .....</b>	<b>9</b>
2.4. TCS Rear Panel .....	5	8.1. Data List .....	9
<b>3. Installation.....</b>	<b>5</b>	8.2. Dimensions.....	9
3.1. Preparations for Installation .....	5	<b>9. Wiring Diagram .....</b>	<b>10</b>
3.2. Mains Power Connection.....	5	<b>10. Accessories .....</b>	<b>11</b>
3.3. Connection Diagram.....	6	<b>11. Spare Parts .....</b>	<b>11</b>
3.4. Connecting The Magnetic Bearing Controller.....	6		
3.5. Connecting The Backing Pump.....	6		
3.6. Connecting The Fore-Vacuum Safety Valve .....	6		
3.7. Connecting The High Vacuum Valve .....	6		
3.8. Connecting The Pressure Gauges.....	6		
3.9. Mains connection.....	6		
3.10. Fitting The Unit Into The Rack .....	6		
<b>4. Function Description, Configurations ..</b>	<b>7</b>		
4.1. Configuration Options .....	7		
Configuration 1 .....	7		
Configuration 2 .....	7		
Configuration 3 .....	7		

**Manufacturer's Declaration (last page)**

# 1. Important For Your Safety

---

- ☞ Read and follow all instructions in this manual.
- ☞ Inform yourself regarding
  - Dangers which can arise from the pumping station
  - Dangers which can arise from your plant.
- ☞ Comply with all safety and accident prevention regulations.
- ☞ Check regularly that all safety and protection requirements are being observed.
- ☞ Do not carry out any unauthorised conversions or modifications on the pump.
- ☞ Only use the permitted plugs.
- ☞ Install the TCS 180 according to the environmental conditions. The protection type is IP 20.  
Protected against foreign material with a diameter of  $\geq 12$  mm. Not protected against water; therefore it must be installed in a suitable housing (see 3. Installation).
- ☞ Housing cover plates must not be opened with connected mains power or while the pump is running.
- ☞ When shipping, please note the instructions in Section 7.



There is danger of an electric shock if the contacts are touched.



There is danger of personal injury.





There is danger of damage to the unit or to the pumping station.

## 2. Understanding The TCS 180

### 2.1. For Your Orientation

#### Symbols used

The following symbols will be used in the illustrations throughout the manual:

-  Fore-vacuum flange
-  Venting connection
-  Power connection

#### Position numbers

The same pump and accessory parts have the same position numbers in all illustrations.

#### Operation instruction In the text

➔ Here, you must do something.

### 2.2. Product Description



This unit complies with the safety requirements for electrical measuring, controlling, regulating and laboratory units as specified by ICE 1010 Part 1/EN61010 Part 1/VDE 0411 Part 1 of March 1994.

The Pumping Station Control Unit TCS 180 is used, in conjunction with the Magnetic Bearing Controller TCM to control and monitor pumping stations and magnetically suspended Turbomolecular pumps.

The TCS 180 control PCB is located in a „U“ shape aluminium casing part which is screwed down with an air permeable, slotted cover.

Pumping Station Control Unit TCS 180 serves the following components:

- High Pressure Vacuum Gauge TPR 250/PKR 250
- High Vacuum Valve
- Fore-Vacuum Safety Valve TVV 001
- Backing Pump
- Magnetic Bearing Controller TCM

A pressure gauge is recommended for monitoring the pressure when a high vacuum valve is being used.

The pressure gauge is operated via the connected magnetic bearing unit.

#### Proper use

The Pumping Station Control Unit TCS 180 is used, in conjunction with the Magnetic Bearing Controller to control and monitor PFEIFFER pumping stations.

- A magnetically suspended bearing electronic unit is required to control the turbopump, venting valve, air cooling, and TMP heating.
- Instructions concerning installation, starting, operating and maintenance must be observed.

#### Improper use

Improper is:

- Uses not covered above and, specifically:
  - The connecting to pumps and units not provided for in their operating manuals;
  - The connecting to units which contain touchable, voltage conducting parts.

Improper use will cause any rights regarding liability and guarantees to be forfeited.

### 2.3 TCS Front View

The front side contains only the four M3 borings required for fitting into the standard 14TE front panel for installation in a 19" rack (see section 7.2., Dimensions).

- X12 - Backing Pump
- X26 - Fore Vacuum Safety Valve
- X13 - High Vacuum Valve
- X27 - High Vacuum Gauge Head TPR 250 or PKR 250
- X9 - Mains Power Connection Socket
- X41.1 - Control Cable to the TCM 180
- X5.1 - Mains Power Cable to the TCM 180
- F1 - Mains Fuse
- F2 - Fuse (Fore-Vacuum Safety Valve)
- A - Operating Voltage Selector Switch

### 2.4 TCS Rear Panel

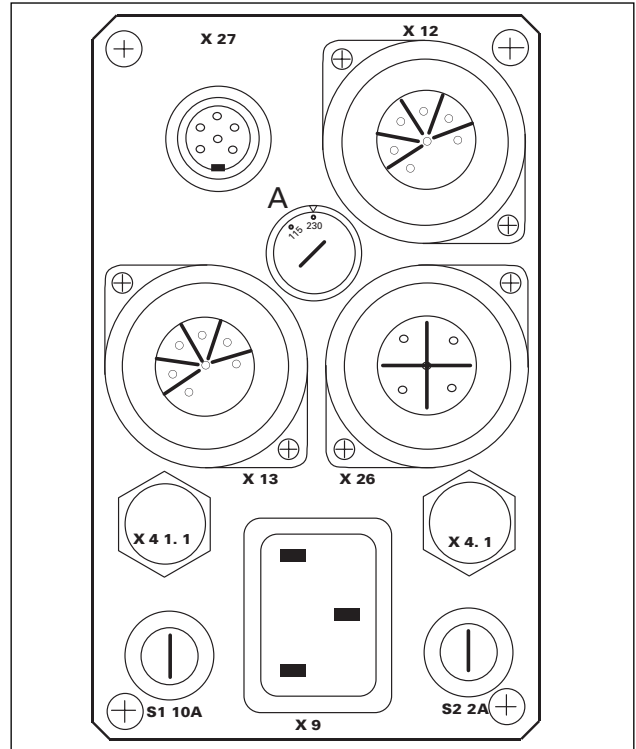

## 3. Installation

### 3.1. Preparations For Installation



Unauthorised modifications or alterations to the Pumping Station Control Unit are not allowed.

For power connection please refer to the wiring diagram PM 041 175 -S (see section 9).

➔ Disconnect mains power before installation work.

### 3.2. Mains Power Connection



There is danger of an electric shock if the contacts are touched.

➔ Mains power connections must be carried out in compliance with local regulations.

The voltage range is 90V-122V AC or 195V-265V AC.

➔ Set selector switch A on the TCS 180 to the voltage applicable.

### 3.3. Connection Diagram

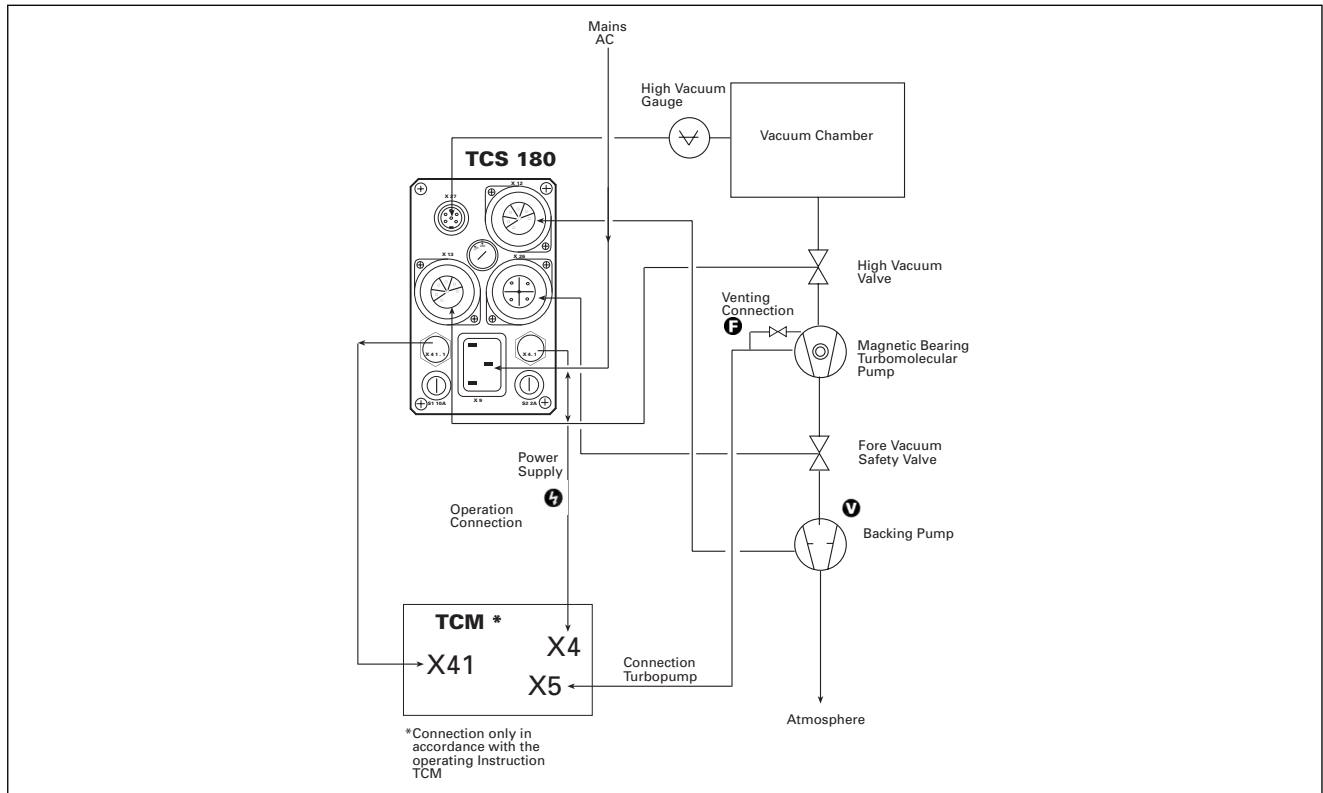

### 3.4. Connecting The Magnetic Bearing Controller

- ➔ Provide mains power supply from the TCS 180 to the Magnetic Bearing Controller TCM 180 via mains power cable X4.1.
- ➔ Connect control cable X41.1/TCS 180 to X41 on the TCM 180.

### 3.5. Connecting The Backing Pump

- ➔ The backing pump is connected to the TCS 180 via plug connector X12. For this it is necessary to solder the backing pump cable to the plug supplied in accordance with Wiring Diagram PM 041 175-S. If a monitoring contact is not available, contacts 5 and 6 should be bridged.

### 3.6. Connecting The Fore-Vacuum Safety Valve

- ➔ Connect fore-vacuum safety valve to X26 with the delivered plug.

### 3.7 Connecting the High Vacuum Valve

If the pumping station is being operated without the high vacuum safety valve, X13 must be plugged into with bridges 3,4 and 5,6.

- ➔ The high vacuum valve is connected to the TCS 180 via plug connector X13. The integrated bridges 3,4 and 5,6 should be removed.

### 3.8. Connecting The Pressure Gauge

- ➔ Connect cable of Gauge Head TPR 250 or PKR 250 (Accessories) to X27.

### 3.9 Mains Connection

- ➔ Mains lead X4.1 should be connected, if necessary, to the magnetic bearing unit X4.
- ➔ Connect the TCS 180 to the mains via X9 with the mains cable (Accessory).

### 3.10. Fitting The Unit Into The Rack

The TCS 180 has been designed in compliance with Protection Class IP 20. It must be fitted into a housing which is compatible with the ambient conditions.

The pumping station control unit is designed to be fitted into a 19" rack. When fitting please note the following:

- ➔ Unscrew the four M3 screws from the standard front panel 14TE.
- ➔ Connect rack front panel (see Accessories) to the earthing connection.
- ➔ Screw rack front panel onto the TCS 180 with four M3 screws.

The rack front panel is not included in the consignment; please refer to Section 10, Accessories.

### Rack Housing

- ➔ Insert the housing and attach the front panel to the rack housing.

### Other Housings

Screw down the unit to the base plate with four screws M5 using the holder provided (refer also to Dimensions, Section 8.2.).

## 4. Function Description, Configurations

The TCS 180 can only reasonably fulfil its function in conjunction with a magnetic bearing controller TCM. The TCM control software ensures that the magnetically suspended bearing pump can be operated safely in various pumping station configurations.

The software recognises automatically that the following components are connected to the TCS 180:

- Pressure gauge
- High vacuum valve
- Backing pump

The fore-vacuum safety valve is connected parallel to the backing pump and is switched on and off with this pump.

The high vacuum valve is operated either dependent on the high vacuum pressure or the turbopump rotation speed.

### 4.1. Configuration Options

For operating the HV gauges please have a look at the notes for the presettings in the operating instruction TCM.

Three configuration options are available for a pumping station with TCS 180:

### Configuration 1

- Pumping station comprising
- Turbomolecular Pump
  - Backing pump
  - Fore-vacuum safety valve

In this case a special HV valve bridging plug must be plugged into socket X13 on the TCS 180 (see 3.7.).

### Configuration 2

- Pumping station comprising
- Turbomolecular Pump
  - Backing pump
  - Fore-vacuum safety valve
  - High vacuum pressure gauge

### Configuration 3

- Pumping station comprising
- Turbomolecular Pump
  - Backing pump
  - Fore-vacuum safety valve
  - High vacuum valve
  - High vacuum pressure gauge

## 5. Operations

If a failure appears or the turbopump is shut down, the backing pump is switched off and the fore vacuum safety valve closed.

In this configuration, a high vacuum gauge head has only the function of a pressure indication.

### 5.1. Operations without High Vacuum Valve

#### Switching On

- ➔ Switch on the TCM with S1 on the rear side.
- ➔ Perform pre-settings on the TCM (start-up time, rotation speed switchpoint, high vacuum gauge head type etc.) in accordance with the operating instructions for the TCM.
- ➔ Switch on the pumping station with switch  on the TCM.

Once the self test has been completed the backing pump and the turbopump are started and the fore-vacuum safety valve opens delayed.

#### Switching Off

- ➔ Switch off the pumping station by pressing switch  on the TCM.

Turbopump and backing pump are switched off. High vacuum and fore-vacuum valve close. Venting proceeds after setting the venting selection switch S2 on the TCM.

- ➔ The TCM is switched off via S1 only after the turbopump is at rest.

### 5.2. Operations With High Vacuum Valve

The turbopump rotation speed and an adjustable high vacuum pressure threshold serve as control parameters whereby the high vacuum absolute pressure is measured with a vacuum gauge head (TPR 250 or PKR 250).

If operation of the high vacuum valve is released via the TCS 180, the valve can be opened or closed by a switch in the feed line.

The switch must be installed by the customer.

- ➔ See also wiring diagram PM 041 175 -S, page 10, connection X13, PIN 1 to the high vacuum valve.

#### Switching On

- ➔ Switch on as for operations without the high vacuum valve.

The release for the operation of the high vacuum valve is performed via the rotation speed and the set rotation speed switchpoint.

If a high vacuum gauge head is not fitted the opening of the high vacuum valve is not possible above a certain pump rotation speed.

The following table offers the possibilities for using and release of the high vacuum valve for pumping station configuration 3 at the TCM 180 or TCM 1601.

Status pumping station		Status HV-valve	Operating HV-valve
PHV-Ist > PHV-Schalt	$f_{\text{ist}} < 300 \text{ Hz}$	open or closed	released, free operation allowed
	$f_{\text{ist}} > 300 \text{ Hz}$	open	released, only closing allowed
closed		locked, opening not allowed	
PHV-Ist < PHV-Schalt	$f_{\text{ist}} < f_{\text{end}} \cdot f_{\text{spkt}}\%$	open	released, only closing allowed
		closed	gesperrt, opening not allowed
	$f_{\text{ist}} > f_{\text{end}} \cdot f_{\text{spkt}}\%$	open or closed	released, free operation allowed

#### Formula sign

$P_{\text{HV-Ist}}$ [mbar] =	actual high vacuum pressure
$P_{\text{HV-Schalt}}$ [mbar] =	High vacuum pressure threshold
$f_{\text{ist}}$ [Hz] =	actual rotation speed turbopump
$f_{\text{spkt}}\%$ [%] =	Rotation speed switch point turbopump
$f_{\text{end}}$ [Hz] =	Final rotation speed turbopump

#### Abbreviations

DZP =	Adjustable rotation speed switchpoint
$f_{\text{Sp}}$ =	under rotation speed turbopump (safe against inrush; set on the TCM)

#### Relevant adjustable parameters

- High vacuum pressure threshold:  $1 \cdot 10^{-1}$  to 5 mbar ( $P_{\text{HV-Schalt}}$ )
- High vacuum pressure gauge: A=TPR 250, B=PKR 250
- Rotation speed switchpoint turbopump: 50 - 90% of the final rotation speed ( $f_{\text{spkt}}\%$ ) (in the rotation speed setting mode set to 20% of the turbo final rotation speed).

#### Relevant, not adjustable parameters

- Rotation speed switchpoint: set at 300 Hz

### 5.3. Pumping Station Behaviour In Case Of Malfunction

#### In Configuration 1, 2 And 3

In the case of a malfunction the turbopump motor current is switched off, the high vacuum slide and the fore-vacuum safety valve closed and the backing pump switched off.

#### Reasons of malfunction

See Error Code Table in the operating instruction of the TCM.

If the turbopump had been vented via the venting valve and at the time the malfunction disappears still as high rotation speed, the pumping station is brought back into operation.

#### Explanation:

Once a malfunction has been removed (e.g. emergency current) and after acknowledgment of a starting time error or a turbopump vibration error, the turbopump must exceed a rotation speed threshold of 100 Hz before re-starting.

In this way contact with the emergency bearing caused by rapid pressure fluctuations is avoided. If the turbopump rotation speed falls below 100 Hz, the turbopump motor current is switched on, the backing pump is switched on and the fore-vacuum safety valve is opened.

If the turbopump has not been vented the complete pumping station goes into operation once the malfunction has been removed.

## 6. What To Do In Case Of Breakdowns ?

Malfunctions arising in the pumping station appear on the TCM LC display.

Display codes are explained in the TCM operating manual.



## 7. Maintenance, Service

Pumping Station Control Unit TCS 180 requires no maintenance. Should the unit require external clearing it must be disconnected from the mains.

### Do Make Use Of Our Service Facilities

In the event that repairs are necessary a number of options are available to you to ensure any system down time is kept to a minimum:

- Have the unit repaired on the spot by our Service Engineers;
- Return the unit to the manufacturer for repairs;
- Replace with a new value unit.

Local PFEIFFER representatives can provide full details.

The enclosed wiring diagram shows the power conducting current paths and the relevant operations voltages.

When carrying out their own repairs customers must bear in mind that dangerous voltage levels are present. In the wiring diagram those parts bearing mains voltage are enclosed in a broken line.

When carrying out repairs or maintenance work on the units it is important to comply with all safety regulations governing the handling of substances hazardous to health.

### Please Note:

Units returned to us for repair or maintenance are covered by our general conditions of sale and supply.

### Contact Addresses and Telephon Hotline

Please refer to the back cover for contact addresses and telephone hotline numbers.

## 8. Technical Data

### 8.1. Data List

Pumping Station Control Unit TCS 180		
Connection voltage	V AC	90-122 195-265
Phases		1
Frequency	Hz	50/60
Fuse (mains)	A	10/16 <sup>2)</sup>
Fuse (fore-vacuum safety valve)	A	2
Installed load, max.of the turbopump	VA	1000
Switching capacity, max./constant power, of the backing pump	kVA	2,0
Activating power, max.constant power, of the fore-vacuum safety valve	VA	260
Activating power, max.constant power, of the high vacuum valve	VA	260
Permissible ambient temperature	°C	5-40
Weight	kg	1,5

<sup>2)</sup> In operations with 2 kVA and 110 V

### 8.2 Dimensions

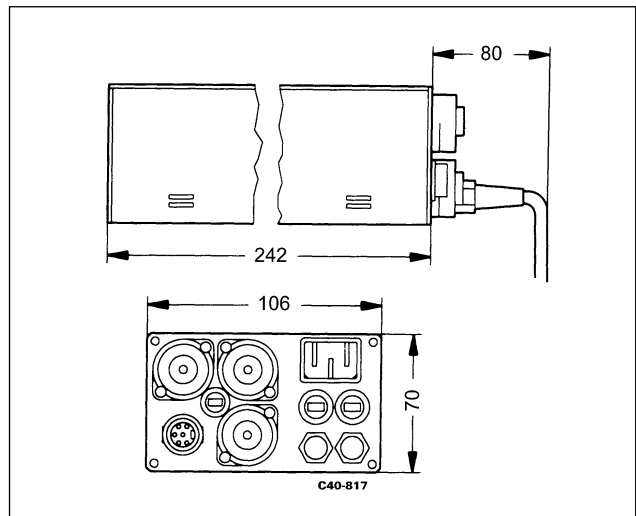

# 9. Wiring Diagram

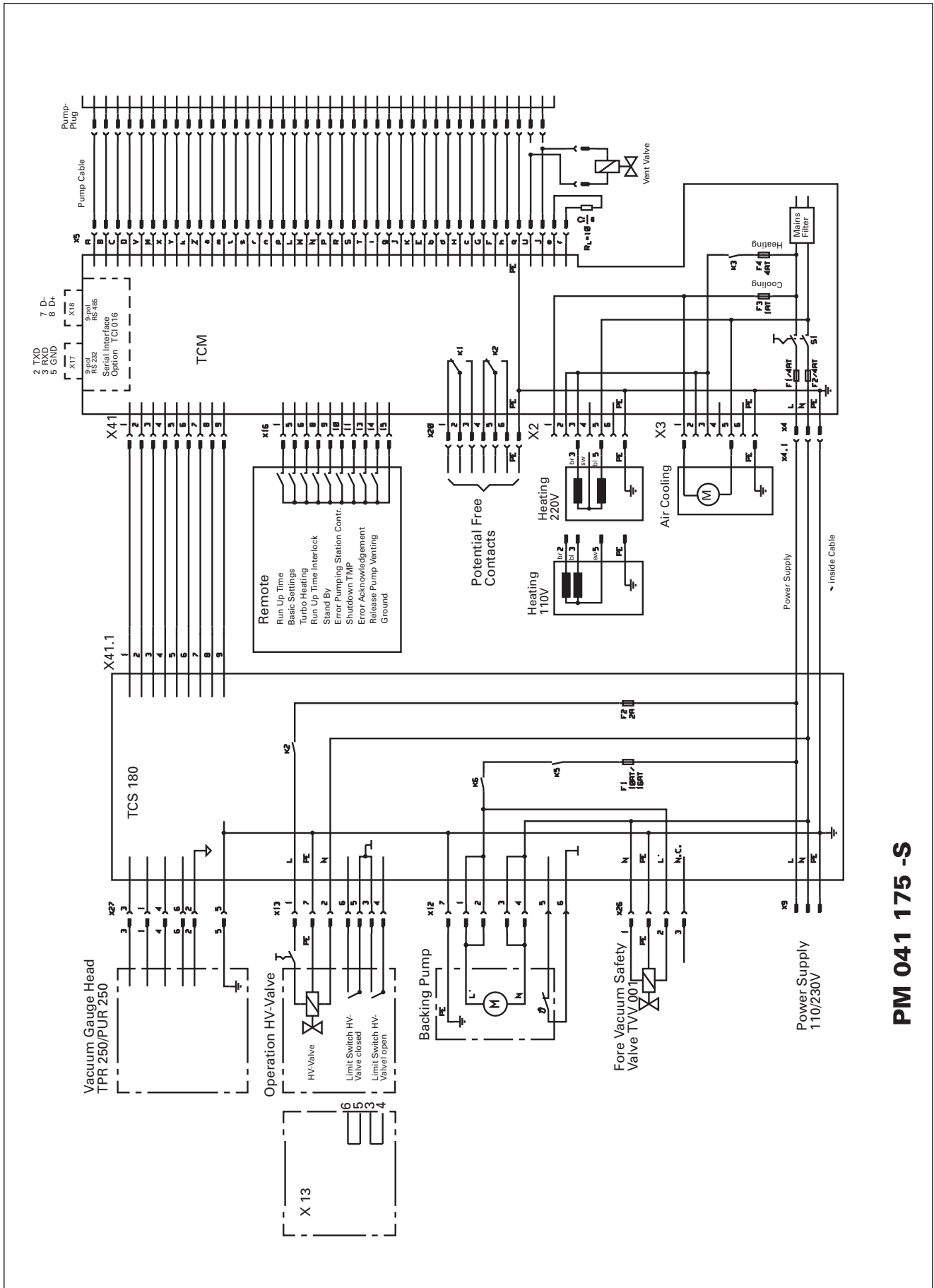

**PM 041 175 -S**

## 10. Accessories

Pumping Station Control Unit TCS 180				
Description		Quantity	Nr.	Order Quantity
Front Panel		1	PM 031 553 -X	
Gauge Head Cable 3m		1	PM 448 250 -T	
Pirani Gauge Head TPR 250	230V	1	BG 441 900 -T	
	120V	1	BG 441 901 -T	
	100V	1	BG 441 902 -T	
Compact Full Range Gauge PKR 250	230V	1	BG 441 915 -T	
	120V	1	BG 441 916 -T	
	100V	1	BG 441 917 -T	
Mains Cable		1	P4564 309 ZA	

## 11. Spare Parts

Pumping Station Control Unit TCS 180				
Description		Quantity	Number	Order Quantity
Fuse 1AT,F2		1	P 4666 436	
Fuse 10AT,F1		1	P 0920 518 E	
Mating Plug X12/13		1	P029 391 E	
Mating Plug X26		1	P029 390 E	
Mating Plug X27		1	P 098 7734	

When ordering accessories and spare parts please state the full part number. When ordering spare parts please state additionally the unit type and number (see rating plate).

Please use this list as order form (by taking a copy).



## **Konformitätserklärung** **Declaration of Conformity**



im Sinne folgender EU-Richtlinien:  
*pursuant to the following EU directives:*

- **Elektromagnetische Verträglichkeit/*Electromagnetic Compatibility***  
**89/336/EWG**
- **Niederspannung/*Low Voltage*** **73/23/EWG**

Hiermit erklären wir, daß das unten aufgeführte Produkt den Bestimmungen der EU-Richtlinie über elektromagnetische Verträglichkeit 89/336/EWG und der EU-Niederspannungsrichtlinie 73/23/EWG entspricht.

*We hereby certify that the product specified below is in accordance with the provision of EU Electromagnetic Compatibility Directive 89/336/EEC and EU Low Voltage Directive 73/23/EEC.*

**Produkt/*Product:***

**Pumpstandsteuergerät TCS 180**

Angewendete Richtlinien, harmonisierte Normen und angewendete, nationale Normen:

*Guidelines, harmonised standards, national standards which have been applied:*

**EN 61 010, EN 55 011, EN 50 081-1, EN 50 082 -2, IEC 801 1-4, VDE 0843-6**

Unterschrift/*Signature:*

Pfeiffer-Vacuum GmbH  
Emmeliusstrasse 33  
35614 Asslar  
Germany

(W. Dondorf)  
Geschäftsführer  
*Managing Director*

## Zentrale/Headquarters

Pfeiffer Vacuum GmbH

Emmeliusstrasse 33  
D-35614 Asslar

Telefon 06441/802-0  
Telefax 06441/802-202  
Hotline 06441/802-333  
Internet:  
<http://www.pfeiffer-vacuum.de>

### Argentina

ARO S.A., Casilla de Correo 4890,  
1000 Buenos Aires, telephone +54 / 1 331 3918,  
telefax +54 / 1 331 3572

### Australia

Balzers Australia Pty. Ltd., Level 1,  
3, Northcliff Street, Milsons Point, NSW 2061,  
telephone +61 / 2 9954 1925, telefax +61 / 2 9954 1939

### Austria

Pfeiffer Vacuum Austria GmbH  
Diefenbachgasse 35, A-1150 Wien,  
telephone +43 / 1 8941 704, telefax +43 / 1 8941 707  
Service Hotline: +43 / 1 8941704

### Branch Office, Czech Republic

Pfeiffer Vacuum Austria GmbH, Branch Prague  
Zvonarska 885  
CZ-156 00 Praha 5  
telephone + 420/2 900 42981  
telefax + 420/2 579 23014

### Belgium / Luxemburg

Pfeiffer Vacuum Belgium N.V./S.A.  
Luxemburgstraat 5, B-1940 Temse  
telephone +32 / 3 710 5920, telefax +32 / 3 710 5929  
Service Hotline: +32 / 3 710 5922

### Brazil

Elmi Tec  
Assistencia Técnica e Representação S/C Ltda.  
Rua Bernadino de Compos, 551  
CEP 04620-002 São Paulo, SP - Brasil  
telephone +55 / 11 532 0740  
telefax +55 / 11 535 3598

### Chile

BERMAT S.A., Coyancura 2283, piso 6  
Providencia, P.O. Box 9781, Santiago  
telephone +56 / 2 231 8877,  
telefax +56 / 2 231 4294

### Colombia

Arotec Colombiana S.A., Carrera 15 No.38-17  
P.O. Box 050 862, Santafe de Bogota / D.C.  
telephone +57 / 1 288 7799, telefax +57 / 1 285 3604

### Denmark

Pfeiffer Vacuum Scandinavia AB, Vesterengen 2,  
DK-2630 Taastrup,  
telephone +45 / 43 52 38 00  
telefax +45 / 43 52 38 50

### France

Pfeiffer Vacuum France SAS  
45, rue Senouque, BP 139 F-78531 BUC Cedex  
telephone +33 / (0)1 30 83 04 00  
telefax +33 / (0)1 30 83 04 04

### Germany

Pfeiffer Vacuum GmbH,  
Emmeliusstrasse 33, D-35614 Asslar  
telephone +49 / 6441 802 400  
telefax +49 / 6441 802 399  
Service Hotline: +49 / 6441 802 333

### Great Britain

Pfeiffer Vacuum Ltd.  
2-4 Cromwell Business Centre  
Howard Way, Interchange Park  
Newport Pagnell, MK16 9QS, United Kingdom  
telephone +44 / 1 908 500615  
telefax +44 / 1 908 500616

### Greece

Analytical Instruments S.A., 1 Mantzarou St.,  
GR-15451 Athens,  
telephone +30 / 1 674 8973  
telefax +30 / 1 674 8978

### India

Pfeiffer Vacuum India Ltd.  
25-E Nicholson Road, Tarbund  
Secunderabad 500 009,  
telephone +91 / 40 775 0014, telefax +91 / 40 775 7774

### Israel

ODEM Scientific Applications,  
2 Bergman Street, Science based park  
Rehovod  
telephone +972 8 9366 101,  
telefax +972 8 9366 102

### Italy

Pfeiffer Vacuum Italia S.p.a.  
Via San Martino, 44 I-20017 RHO (Milano)  
telephone +39 / 2 93 99 051, telefax +39 / 2 93 99 05 33

### Japan

Hakuto Co. Ltd., C.P.O. Box 25,  
Vacuum & Scientific Instruments Division  
Tokyo Central 100-91,  
telephone +81 / 3 32 258 910  
telefax +81 / 3 32 259 009

### Korea

Pfeiffer Vacuum Korea Ltd., 3F Haein Building 453,  
Dokok-Dong, Kang Nam-Ku, Seoul, 135-270  
telephone +82 / 2 3461 0671/5  
telefax +82 / 2 3461 0676

### Netherlands

Pfeiffer Vacuum Nederland BV  
Veldzigt 30a, NL-3454 PW De Meern,  
telephone +31 / 30 6666050, telefax +31 / 30 6662794

### Peru

Ing. E. Brammert s.r.l., José Pardo 182,  
Apartado 173, PE-18 Miraflores,  
telephone +51 / 1 445 8178  
telefax +51 / 1 445-1931

### Poland

Softrade Sp.z.o.o, ul. Grunwaldzka 391,  
PL-60-173 Poznan, telephone +48 / 61 8677 168,  
telefax +48 / 61 8677 111

### Portugal

Unilaser Lda, Taguspark  
Núcleo Central, sala n° 268, Estrada Cacém-  
Porto Salvo, P-2780 Oeiras  
telephone +351 / 1 421 7733  
telefax +351 / 1 421 7744

### Singapore

APP Systems Services Pte. Ltd, 2 Corporation Road  
06-14 Corporation Place, Singapore 618494,  
telephone +65 / 268 2024, telefax +65 / 268 6621

### Spain

Tecnovac  
Tecnologia de Vacio S.L., Ronda de Poniente, 6 Bajo F  
Centro Empresarial Euronova  
E-28760 Tres Cantos (Madrid)  
telephone +34 / 91 804 11 34,  
telefax +34 / 91 804 30 91

### Sweden

Pfeiffer Vacuum Scandinavia AB  
Johanneslundsvägen 3  
S-194 61 Upplands Väsby  
telephone +46 / 590 748 10  
telefax +46 / 590 748 88

### Switzerland

Pfeiffer Vacuum Schweiz S.A.  
Förlibuckstraße 30, CH-8005 Zürich  
telephone +41 / 1 444 2255,  
telefax +41 / 1 444 2266

### South Africa

Labotec Pty Ltd., P.O. Box 6553,  
Halfway House  
1685 Midrand  
telephone +27 / 11 315 5434  
telefax +27 / 11 315 5882

### Taiwan

HAKUTO Taiwan Ltd. Hsinchu office No. 103,  
Hsien Chen 11th Street, Jubei City,  
HsinChu County, Taiwan, R.O.C.  
(zip/postal code: 302)  
telephone +886 / 3 554 1020  
telefax +886 / 3 554 0867

### Thailand

S & T Enterprises (Thailand) Ltd.  
18th Floor, Chokchai Int'l Bldg.  
690 Sukhumvit Road  
Klongton, Klongtoey  
Bangkok 10110  
telephone +662 / 259 4623  
telefax +662 / 259 6243

### U.S.A.

Pfeiffer Vacuum, Inc.  
24 Trafalgar Square  
Nashua, NH 03063-1988  
USA  
telephone +1/ 603 578 6500  
telefax +1/ 603 578 6550

### Venezuela

Secotec S.A., Apartado 3452, Caracas 1010-A,  
telephone +58 / 2 573 8687  
telefax +58 / 2 573 1932

### Other countries

AVI - Applied Vacuum Industries GmbH  
Leginglenstrasse 17A; CH-7320 Sargans  
Switzerland  
telephone +41 / 81 710 03 80  
telefax +41 / 81 710 03 81

### Scope of represented countries

Armenia, Azerbaijan, Bangladesh, Belarus, Bulgaria,  
Cambodia, Estonia, Georgia, Hong Kong, Kazakhstan,  
Kingdom of Nepal, Kirghizia, Latvia, Lithuania,  
Maldavia, Philippines, P.R. China, Rumania, Russia,  
Tajikistan, Turkmenistan, Ukraine, Uzbekistan, Vietnam

### A.E.M.S.

Advanced Equipment Materials and Systems  
P.O. Box 25  
Föhrenweg 18  
FL-9496 Balzers  
telephone +41 / 75 380 0550  
telefax +41 / 75 380 0551

### Scope of represented countries

Bahrain, Egypt, Iraq, Iran, Jordan, Kuwait, Lebanon,  
Lybia, Oman, Pakistan, Saudi-Arabia, Sudan, Syria,  
Turkey, United Arab Emirates, Yemen